

CROSLEY

CR1701A

iJuke

Instruction Manual

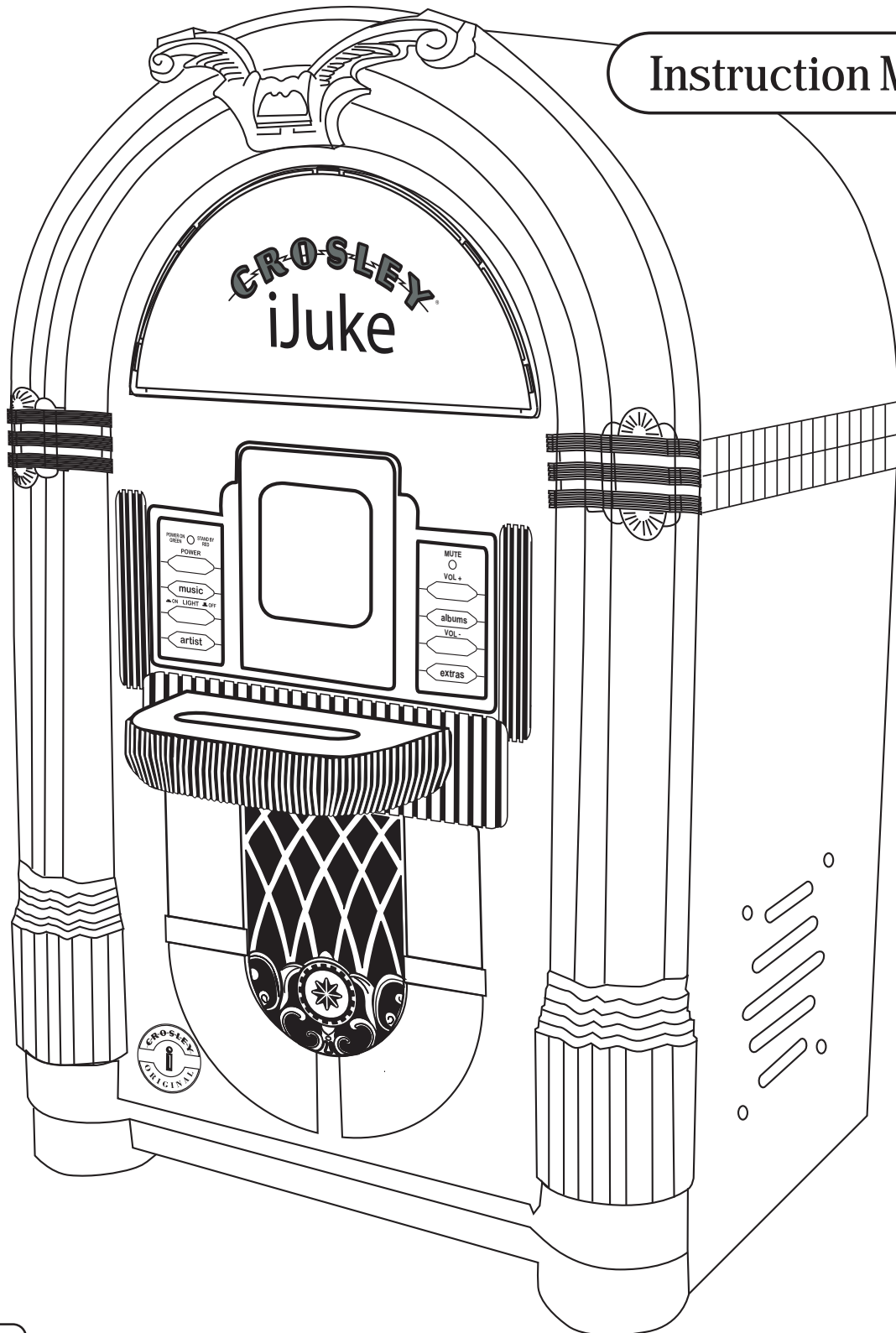

www.crosleyradio.com

IMPORTANT SAFETY INSTRUCTION

PLEASE READ CAREFULLY ALL THE FOLLOWING IMPORTANT SAFEGUARDS THAT ARE APPLICABLE TO YOUR EQUIPMENT

1. Read Instructions - All the safety and operating instructions should be read before the product is operated.
2. Retain instructions - The safety and operating instructions should be retained for future reference.
3. Heed Warnings - All warnings on the product and in the operating Instructions should be adhered to.
4. Follow Instructions - All operating and use instructions should be followed.
5. Cleaning - Unplug this product from the wall outlet before cleaning. Do not use liquid cleaners or aerosol cleaners. Use a damp cloth for cleaning.
6. Attachments - Do not use attachments not recommended by the product manufacturer as they may cause hazards.
7. Water and Moisture - Do not use this product near water - for example, near a bath tub, wash bowl, kitchen sink, or laundry tub; in a wet basement; or near a swimming pool; and the like.
8. A product and cart combination should be moved with care. Quick stops, excessive force, and uneven surfaces may cause the product and cart combination to overturn.
9. Ventilation - Slots and openings in the cabinet are provided for ventilation and to ensure reliable operation of the product and to protect it from overheating, and these openings must not be blocked or covered. The openings should never be blocked by placing the product on a bed, sofa, rug, or other similar surface. This product should not be placed in a built-in installation such as a bookcase or rack unless proper ventilation is provided or the manufacturer's instructions have been adhered to.
10. Power Sources - This product should be operated only from the type of power source indicated on the marking label, if you are not sure of the type of power supply to your home. Consult your product dealer or local power company. For products intended to operate from battery power, or other sources, refer to the operating instructions.
11. Grounding or Polarization - This product may be equipped with a polarized alternating-current line plug (a plug having one blade wider than the other). This plug will fit into the power outlet only one way. This is a safety feature. If you are unable to insert the plug fully into the outlet try reversing the plug. If the plug should still fail to fit, contact your electrician to replace your obsolete outlet. Do not defeat the safety purpose of the polarized plug.
12. Power - Cord Protection - Power - supply cords should be routed so that they are not likely to be walked on or pinched by items placed upon or against them, paying particular attention to cords at plugs, convenience receptacles, and the point where they exit from the product.
13. Lightning - For added protection for this product during a lightning storm, or when it is left unattended and unused for long periods of time, unplug it from the wall outlet and disconnect the antenna or cable system. This will prevent damage to the product due to lightning and power - line surges.
14. Power Lines - An outside antenna system should not be located in the vicinity of overhead power lines or other electric light or power circuits, or where it can fall into such power lines or circuits. When installing an outside antenna system, extreme care should be taken to keep from touching such power lines or circuits as contact with them might be fatal.
15. Overloading - Do not overload wall outlets, extension cords, or integral convenience receptacles as this can result in a risk of fire or electric shock.
16. Object and Liquid Entry - Never push objects of any kind into this product through openings as they may touch dangerous voltage points or short - out parts that could result in a fire or electric shock. Never spill liquid of any kind on the product.
17. Servicing - Do not attempt to service this product yourself as opening or removing covers may expose you to dangerous voltage or other hazards. Refer all servicing to qualified service personnel.
18. Damage Requiring Service - Unplug this product from the wall outlet and refer servicing to qualified service personnel under the following conditions;
 - a. When the power-supply cord or plug is damaged.
 - b. If liquid has been spilled, or objects have fallen into the product.
 - c. If the product has been exposed to rain or water.
 - d. If the product does not operate normally by following the operating instructions. Adjust only those controls that are covered by the operating instructions as an improper adjustment of other controls may result in damage and will often require extensive work by a qualified technician to restore the product to its normal operation.
 - e. If the product has been dropped or damaged in any way.
 - f. When the product exhibits a distinct change in performance - this indicates a need for service.
19. Replacement Parts - When replacement parts are required, be sure the service technician has used replacement parts specified by the manufacturer or have the same characteristics as the original part. Unauthorized substitutions may result in fire, electric shock, or other hazards.
20. Safety Check - Upon completion of any service or repairs to this product, ask the service technician to perform safety checks to determine that the product is in proper operating condition.
21. Wall or ceiling Mounting - The product should be mounted to a wall or ceiling only as recommended by the manufacturer.
22. Heat - The product should be situated away from heat sources such as radiators. Heat registers, stoves, or other products (including amplifiers) that produce heat.

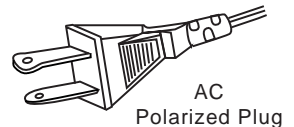

WARNING: Changes or modifications to this unit not expressly approved by the party responsible for compliance could void the user's authority to operate the equipment.

NOTE: This equipment has been tested and found to comply with the limits for a Class B digital device, pursuant to Part 15 of the FCC Rules. These limits are designed to provide reasonable protection against harmful interference in a residential installation. This equipment generates, uses, and can radiate radio frequency energy and, if not installed and used in accordance with the instructions, may cause harmful interference to radio communications. However, there is no guarantee that interference will not occur in a particular installation. If this equipment does cause harmful interference to radio or television reception, which can be determined by turning the equipment off and on, the user is encouraged to try to correct the interference by one or more of the following measures:

- Reorient or relocate the receiving antenna.
- Increase the separation between the equipment and receiver.
- Connect the equipment into a circuit different from that to which the receiver is connected.
- Consult the dealer or an experienced radio TV technician for help.

WARNING:

TO PREVENT FIRE OR SHOCK HAZARD, DO NOT EXPOSE THIS APPLIANCE TO RAIN OR MOISTURE. DO NOT REMOVE COVER. PILOT LAMPS SOLDERED IN PLACE. NO USER SERVICEABLE PARTS INSIDE. REFER SERVICING TO QUALIFIED SERVICE PERSONNEL.

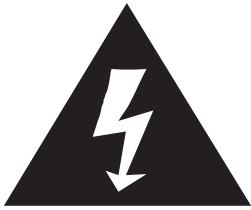

The lightning flash with arrowhead symbol, within an equilateral triangle, is intended to alert user to the presence of uninsulated "dangerous voltage" within the product's enclosure that may be of sufficient magnitude to constitute risk of electric shock to persons.

CAUTION

**RISK OF ELECTRIC SHOCK
DO NOT OPEN**

CAUTION: TO REDUCE THE RISK OF ELECTRIC SHOCK, DO NOT REMOVE COVER (OR BACK). NO USER - SERVICEABLE PARTS INSIDE. REFER SERVICING TO QUALIFIED SERVICE PERSONNEL.



The exclamation point within an equilateral triangle is intended to alert user to the presence of important operating and maintenance (servicing) instruction in the literature accompanying the appliance.

Specification

Power Source	:	Input AC120V 60Hz Output DC15V 1100mA
Power Consumption	:	25W
Speaker	:	Dynamic type 4" 4 Ohm x 2

* DESIGN AND SPECIFICATIONS SUBJECT TO CHANGE WITHOUT NOTICE.

Welcome

Thank you for purchasing the Crosley iJuke (CR1701A). Before operating this unit, please read this manual thoroughly and retain it for future reference.

About This Manual

Instructions in this manual describe the control functions of the iJuke (CR1701A).

Table of Contents

Getting Started

Control Locator.....	4-5
Unpacking.....	6
Set Up.....	6

Basic Operation

Using your iJuke.....	7
Remote Control.....	8
Lights	8

Connecting Optional Equipment

External Outputs.....	9
Auxiliary Inputs.....	9

General

Troubleshooting	10
-----------------------	----

Control Locator

Unit Controls

- 1 Power Indicator
- 2 Power On/Off
- 3 Lights On/Off
- 4 Universal Dock
- 5 Remote Sensor
- 6 Speakers
- 7 Mute Indicator
- 8 Volume Up
- 9 Volume Down
- 10 Remote Storage
- 11 Auxiliary Input (Aux In)
- 12 Speaker Jacks
- 13 Internal / External Speaker Switch (EXT. / INT.)
- 14 Stage Light Stop & Run Switch
- 15 DC Jack

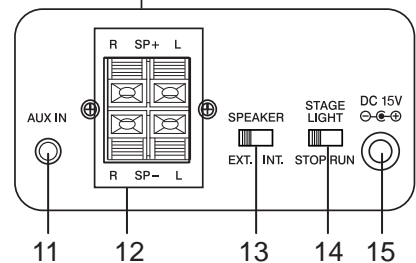
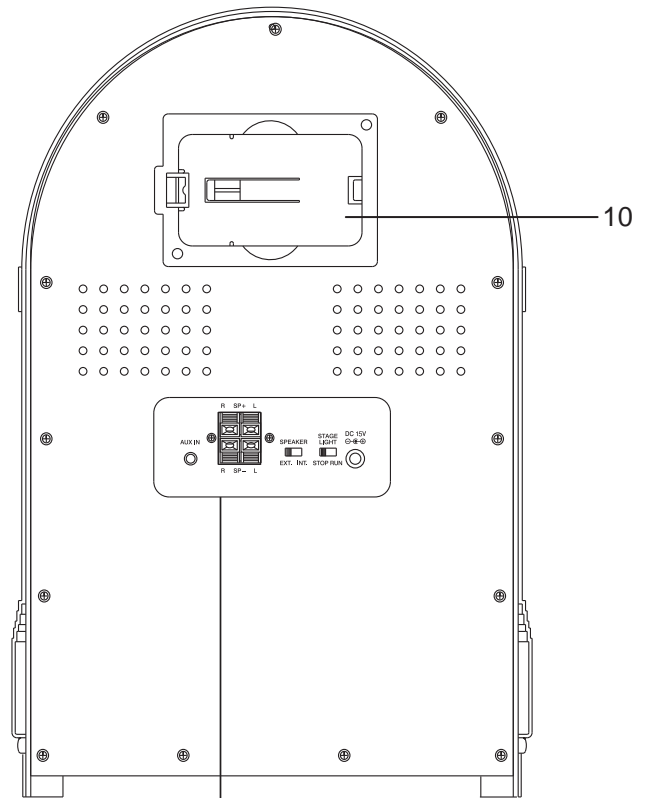
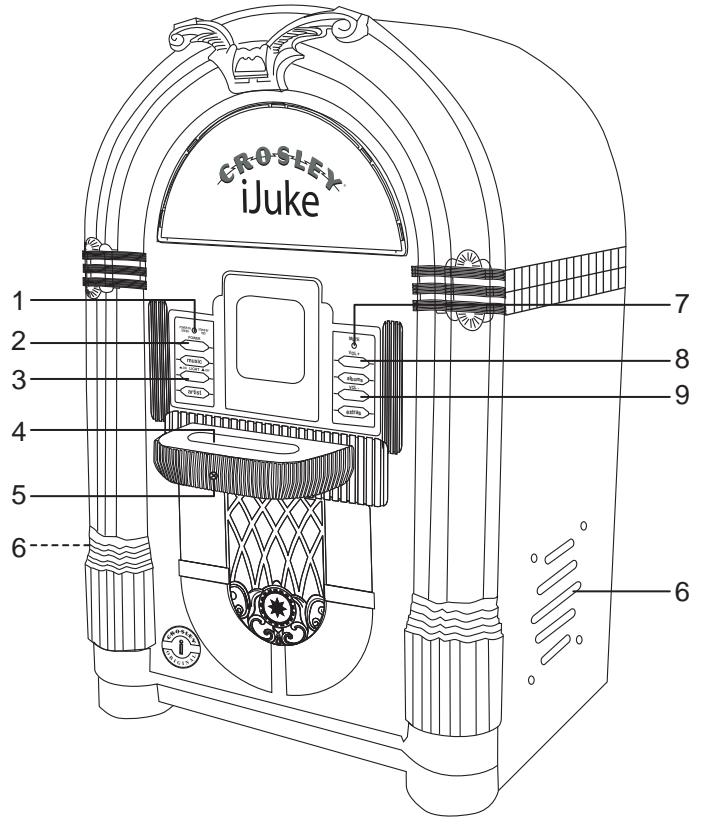

Control Locator

Remote Controls

- 16 Power
- 17 Backward Skip
- 18 Play / Pause
- 19 Up Select
- 20 Down Select
- 21 Repeat
- 22 Select
- 23 Menu
- 24 Mute
- 25 Forward Skip
- 26 Volume Up
- 27 Volume Down

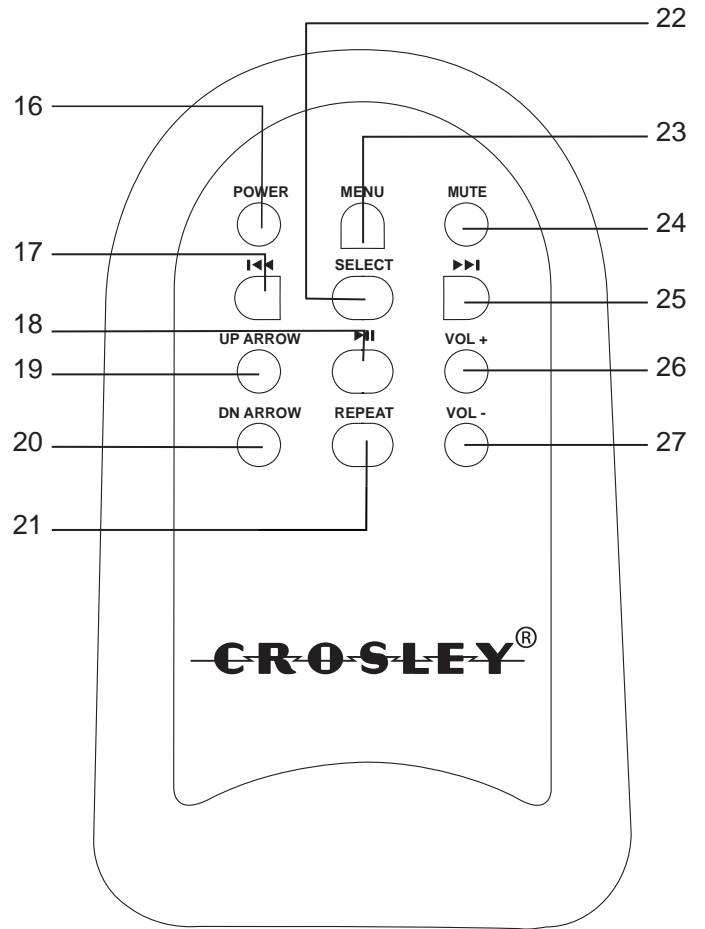

Getting Started

Unpacking

- 1 Remove unit from box and remove all packing materials.
Note: Save the box and packing materials in case the unit needs to be transported or returned.
- 2 Remove plastic safety cover from A/C plug.
- 3 Remove tie from A/C cord.
- 4 Remove tie from A/C adapter.

Set Up

- 1 Check the carton for all the parts shown.

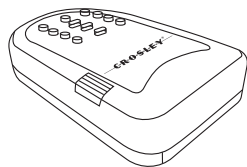

Remote Control

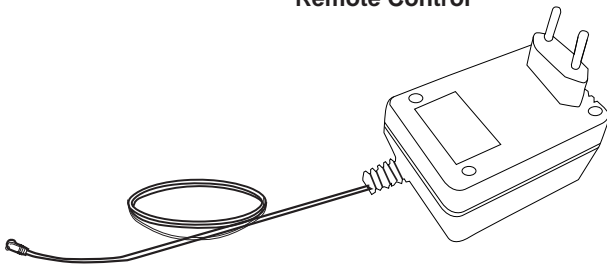

A/C adapter

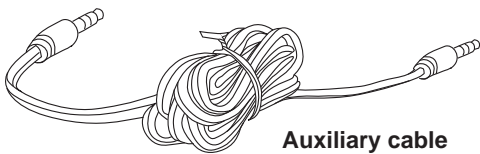

Auxiliary cable

- 2 Plug the small end of the AC adapter into the DC Jack on the back of the unit.
- 3 Plug the adapter pack into an appropriate outlet.

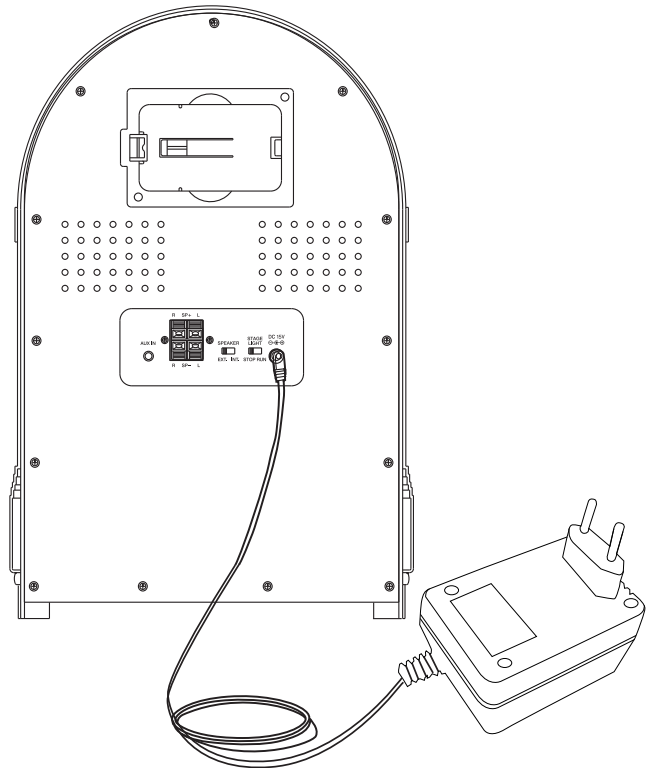

- 4 Remove battery cover from remote control and install 2 AAA batteries (not included). Note the correct battery orientation.

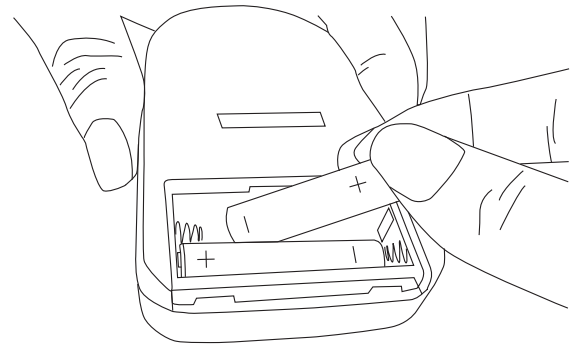

- 5 Place the iJuke on a flat surface.
Note: The speakers in the iJuke are shielded which limits the possibility of video interference if placed near a computer or television monitor.

Basic Operation

Using your iJuke

The iJuke features the Universal Dock that uses dock adapters that come with newer iPod models. Before inserting your iPod, you will need to install the correct dock adapter. By using the correct dock adapter, you can insert any iPod with a dock connector. While docked, the iJuke will also charge your iPod. To connect your iPod, follow the steps below. If your iPod doesn't have a dock connector, you can connect it to the unit by using the Auxiliary Cable that is supplied.

- 1 Insert the correct dock adapter that fits your iPod. Your iPod should fit snugly into the correct adapter. Gently press the adapter until it snaps firmly in place.
- 2 Connect your iPod as shown in the illustration below.

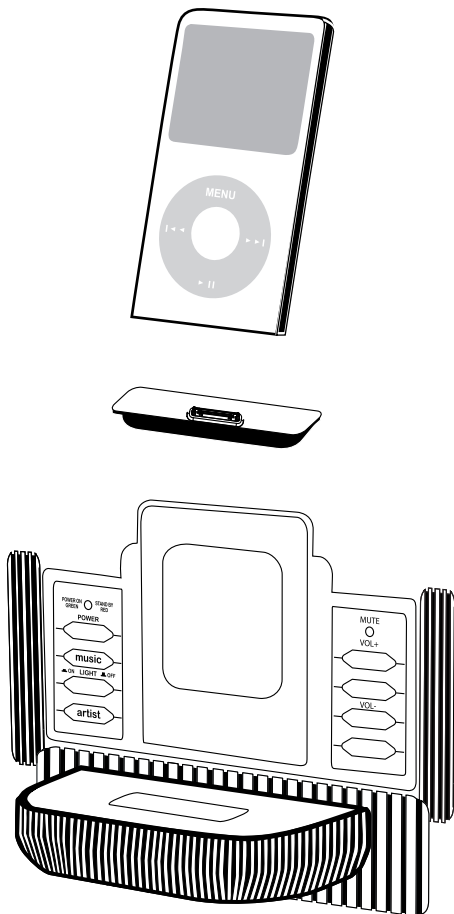

Note: If your iPod does not have a dock connector, use the supplied Auxiliary Cable and hook your iPod to the Auxiliary Input (Aux In) jack on the back of the unit.

- 3 Press the Power button to turn iJuke on.
- 4 Browse your iPod for songs and press the Play/Pause button. Your music should begin to play.
- 5 Adjust the volume to your desired listening level.
- 6 To remove the dock adapter, push your fingernail into the slot in the back of the adapter and lift up.

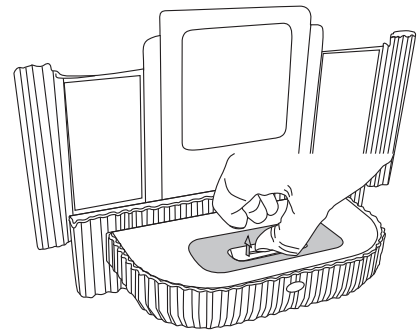

Basic Operation

Remote Control

Included with your iJuke is a full function remote control. It allows you to control the main power and volume of the iJuke and also gives you complete control of your iPod including menu functions on most iPod models. See below for a complete list of the remote functions.

- Power** – The POWER button turns the iJuke on/off. When docked, pressing the power button will also turn your iPod on/off with the unit.
- Menu** – The MENU button allows you to access the menus on your iPod.
- Mute** – The MUTE button mutes the volume of the iJuke.
- ▶▶** – Pressing the FORWARD SKIP button once will take you to the beginning of the next song on your iPod. You can press and hold it to search forwards through the song that is playing.
- ◀◀** – Pressing the BACKWARD SKIP button once takes you to the beginning of the song you are listening to. Press it twice to go to the beginning of the previous song. You can also press and hold it to search backwards through the song that is playing.
- ▶||** – The PLAY/PAUSE button is used to pause the song that is playing. Pressing it twice resumes playback.
- Up Select** – The UP SELECT button moves upwards through the menu selections.
- DN Select** – The DOWN SELECT button moves downwards through the menu selections.
- Select** – The SELECT button enters your selections from the menus.
- Repeat** – The REPEAT button allows you to repeat selected songs on applicable iPod models.
- Vol +** – The VOLUME UP button Increases your volume level.
- Vol -** – The VOLUME DOWN button decreases your volume level.

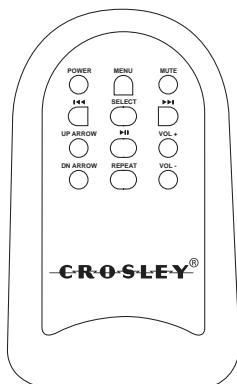

Lights

- 1 To turn on the lights, press the Light button on the front of the unit.
- 2 Adjust the Stage Light Switch to Stop or Run to make the Eternity Lights constant or in motion.

Connecting Optional Equipment

External Outputs

The iJuke is equipped with external speaker outputs which will allow you to hook up external speakers.

- 1 The speaker jacks for external speakers are 4 ohm jacks and are located on the back of the unit. Beside the speaker jacks is the external / internal speaker switch which is labeled (EXT. / INT.) When using external speakers, this switch must be switched to the EXT. position. Doing this turns off the internal speakers in the unit and redirects to power to the external speakers.
- 2 If you decide not to use the external speakers, be sure the switch is on INT. position or the internal speakers will not work.

Auxiliary Inputs

You can connect external audio devices such as CD Players or other MP3 players by using the Auxiliary Input (Aux In) jack and the supplied Auxiliary cable. To connect an external device, follow the directions below.

- 1 Connect one end of the supplied Auxiliary Cable to the Aux In jack on the back of your unit.
- 2 Connect the other end of the cable to the Audio Out Jack or Headphone Jack of your external component.
Note: If your external component doesn't have a 3.5mm output jack or headphone jack, you will need a different cable to make the connection. Check your local electronics retailer for different cable options.
- 3 Begin play on the external component and adjust the volume of the iJuke to your desired listening level.
- 4 See the owner's manual for your external component for information on its operations.



Auxiliary cable

Troubleshooting

There's no power?

- 1 The AC adapter is not connected. Check to make sure it is plugged in correctly.

There's no sound?

- 1 Make sure the mute function is turned off.
- 2 Check that the volume is turned up by pressing Volume Up button on remote.
- 3 Make sure the External / Internal Speakers switch is on INT.
(Unless you are using external speakers, in which case it should be on EXT.)
- 4 Check to make sure power is turned on.
- 5 Make sure the Hold switch on your iPod is in the off position.
- 6 Check that the iPod is not paused.

Remote not working?

- 1 Replace batteries.
- 2 Point remote towards remote sensor when using.

LIMITED MANUFACTURERS WARRANTY

Crosley Radio, Inc. warrants the product to be free from defects in material and workmanship under normal use for a period of one year from the original date of purchase. This warranty is not transferable. If the product is determined to be defective during the warranty period, the unit will be repaired or replaced at Crosley Radio's sole discretion. This warranty covers manufacturing defects and normal consumer use and does NOT cover damage or failure as a result of abuse, accident, alterations, misuse, neglect, abnormal wear and tear, inadequate maintenance, commercial or unreasonable use, damage caused by power surges, mishandling, accident, acts of God or attempted repair by an unauthorized service agent. Also not covered are cosmetic damages, cords and antennas.

Should this product fail to function in a satisfactory manner, it is best to first return it to the store or retailer where it was originally purchased. If additional service is still needed, the original purchaser must **FIRST** contact our offices to obtain an RA (Return Authorization) Number.

TO OBTAIN AN RA NUMBER
CALL: **1.888.CROSLEY**
(1.888.276.7539)

Send the unit prepaid to the address below in the original packaging (or reasonable substitute to prevent damage). Clearly mark your RA number on the outside packaging and include the original sales receipt (or a copy) indicating date of purchase, amount paid, and place of purchase. You must also include your full name, shipping address and daytime contact number. Please include a check or money order in the amount of \$19.95, made payable to Crosley Radio, to cover handling and return shipping charges. Returned products will not be shipped to PO Boxes. Crosley Radio will not be responsible for delays or unprocessed claims resulting from a purchaser's failure to provide any or all of the necessary information.

CROSLEY RADIO
ATTN: RETURNS DEPT
2001 PRODUCTION DRIVE
Louisville, KY 40299

For additional support: Crosley Radio Consumer Service Department
24 hours a day / 7 days a week
Telephone: 1.888.CROSLEY (1.888.276.7539)

*There are no express warranties except as listed above.
The purchaser's bill of sale is the only proof of warranty entitlement.*

This warranty gives the purchaser specified legal rights in addition to any rights which may vary from state to state.

In accordance with the "Moss-Magnuson Warranty Act" of July 10, 1975, this is termed a "limited warranty" which in no way compromises Crosley Radio's high standards of quality and workmanship.